

WATER BATHS

User manual



Natural convection and forced circulation **water baths** with microprocessor temperature controller.

Model	Description	Temperature Range
WB-5	<i>Water bath with natural convection 5L (maximum volume)</i>	<i>Room temperature from + 5°C to +100°C</i>
WB-12	<i>Water bath with natural convection 12L (maximum volume)</i>	<i>Room temperature from + 5°C to +100°C</i>
WB-22	<i>Water bath with natural convection 22L (maximum volume)</i>	<i>Room temperature from + 5°C to +100°C</i>
WB-22 Pump	<i>Water bath with forced circulation 22L (maximum volume)</i>	<i>Room temperature from + 5°C to + 85°C</i>
WB-40 Pump	<i>Water bath with forced circulation 40L (maximum volume)</i>	<i>Room temperature from + 5°C to + 85°C</i>

Producer:

Sozhou Being Medical Device CO., LTD
NO.108 Gongxiang RD Qiandeng Town
Kunshan China

Drafting by the agent:

Giorgio Bormac s.r.l.
Via della Meccanica, 25
41012 Carpi (MO)
P.Iva 02309180368

Tel. +39 059 653274
Fax +39 059 653282
Email info@giorgiobormac.com

Index

1. Safety information	3
• Definitions of warning words and symbols	3
• Reporting terms	3
• Warning symbols	3
• Pictograms	3
• Danger symbols	4
• Prohibition signs	4
• Symbols of obligation	4
2. General safety instructions	5
3. CE marking data	7
4. Content of the package	8
5. Transportation	8
• Instructions for safe transportation	8
• Transportation of an already used water bath	9
6. Conservation	9
7. First installation	9
• Preliminary operations	9
8. Instrument parts	10
• Display and commands	10
9. Technical specifications	11
10. Filling of the tank	12
11. Emptying of the tank	13
12. Functioning	13
• Switching on the instrument	13
• Turn on/off the recirculation pump (If present)	14
• Setting of parameters	14
• Start/Stop heating cycle	14
13. Access to submenu with password	14
• Delay start function	15
• Temperature limit for the sample protection	15
• Restart mode after the absence of the power supply	15
• Temperature limit for over-temperature alarm	16
• Temperature offset on single point, on the entire range, on room temperature sensor	16
14. Clean and maintenance	17
15. Warranty	18
16. Disposal of electronic equipment	18

1. Safety information

- **Definitions of warning words and symbols**

This manual contains extremely important safety information, to avoid personal injury, damage to the instrument, malfunctions or incorrect results due to failure to comply with them. Read entirely and carefully this manual and be sure to familiarize with the tool before starting to work with it. This manual must be kept near to the instrument, so that the operator can consult it easily, if necessary. Safety provisions are indicated with warning terms or symbols.

- **Reporting terms:**

ATTENTION/WARNING/DANGER	for a medium-risk hazardous which could lead to serious injury or death, if not avoided.
ADVICE	for important information about the product.
NOTE	for useful information about the product.

- **Warning symbols:**



DANGER

This symbol indicates an imminently hazardous situation, which, if not avoided, could result in death or serious (irreversible) injury.



WARNING

This symbol indicates a potential hazardous situation, which, if not avoided, could result in death or serious (irreversible) injury.



ATTENTION

This symbol indicates a potential hazardous situation, which, if not avoided, could result in medium or minor injuries (reversible).



ADVICE

This symbol draws attention to possible damage to the instrument or instrumental parts.













NOTE

This symbol highlights further information and tips.

- **Pictograms**

In this manual, there are various symbols identifying dangers, prohibitions, and obligations as illustrated below.



- **Danger symbols**

	Danger of electric shock
	Danger of explosion
	Fire hazard
	Danger of poisoning
	Danger of overheating surfaces
	Danger of damage to health caused by toxic substances
	Danger of injury from overturning of objects
	Risk of injury from lifting heavy objects
	Danger of environmental damage
	Danger of corrosion

- **Prohibition signs**







	Do not wet with water
---	-----------------------

- **Symbols of obligation**

	Disconnect the instrument from the power supply by pulling the plug
	Eye protection must be used

2. General safety instructions







If the water bath is not installed, operated cleaned, adjusted or set up correctly, there is a risk of malfunction which could lead to personal injuries and material damages to the instrument and samples. Therefore, the water bath must only be installed, operated, cleaned, adjusted and set up by qualified personnel.

 DANGER	
  	<p>Risk of electric shock and death</p> <ul style="list-style-type: none"> ⊗ Do not get the instrument wet during installation, commissioning or maintenance. ⊗ Do not connect the instrument to power if the rear panel is dented or damaged. <p>➤ Before opening the side panel, remove the power plug from the power supply.</p> <p>➤ If the power cable or the side panel of the instrument are damaged, stop using them immediately, remove the power plug and contact your supplier for the necessary repairs.</p> <p>➤ All work on the electrical components of the instrument must be operated by qualified personnel only.</p>
	<p>Danger of explosion</p> <p>➤ Install the instrument only where there is no risk of explosion.</p> <ul style="list-style-type: none"> ⊗ Do not keep air/solvent mixtures or explosive dusts nearby. ⊗ Never introduce materials that are explosive or flammable at the selected operating temperature. ⊗ Never introduce materials that contain flammable or explosive solvents into the instrument. ⊗ Never introduce into the instrument materials that by sublimation or pyrolysis create flammable materials at the selected operating temperature.
 	<p>Danger of poisoning and death</p> <ul style="list-style-type: none"> ⊗ Never introduce materials into the instrument whose disintegration could create poisonous gases at the selected operating temperatures.

 **WARNING**

	<p>Fire Hazard</p> <ul style="list-style-type: none"> ⊘ The water baths must not be used if the inspection of the thermostat with safety class 2 has failed. ➤ If the safety thermostat test fails, stop using the water bath, remove the power plug and contact your supplier for the necessary repairs. ➤ Always place the instrument on a working surface that is resistant to a temperature of 100 °C. ⊘ Do not put anything under the instrument (paper, plastic film, etc.). ➤ Always connect the instrument only to a power supply with a fuse of at least 10A. Follow the recommendations of your local power supply company.
---	---

 **ATTENTION**

	<p>Danger of burns</p> <ul style="list-style-type: none"> ➤ The lid of the water bath becomes hot and must not be touched during the functioning of the instrument.
 	<p>Risk of injury and breakage</p> <ul style="list-style-type: none"> ➤ Always place the instrument on surfaces that can support its weight.
	<p>Overturning hazard and risk of injury</p> <ul style="list-style-type: none"> ⊘ Never stack the water baths.
  	<p>Risk of injury, of slipping or overturning and risk of damage to the instrument.</p> <ul style="list-style-type: none"> ➤ The instrument must be lifted by 2 people. ➤ The instrument must be transported in its original packaging only. ➤ The instrument must always be lifted from below with mechanical tools (e.g., forklift truck) together with the supporting pallet. ⊘ The instrument must not be lifted directly from below with mechanical tools without supporting pallets (e.g., forklift truck). ⊘ The instrument must not be lifted or dragged by pulling the door.

3. CE marking data

Argolab instruments are manufactured in compliance with Directive 2006/42/EC and the relevant Community Directives applicable at the time of placing on the market (fac-simile below).

SUZHOU BEING MEDICAL DEVICE.CO.,LTD	DECLARATION OF CONFORMITY UE In accordance with Annex II A - Directive 2006/42/CE Annex IV - EMC Directive and Annex VI - Directive 2011/65/UE (RoHS)	
-------------------------------------	---	---

No. ISETC.002620200624

Manufacturer's Name : SUZHOU BEING MEDICAL DEVICE CO., LTD
 Manufacturer's Address : NO. 108 GONGXIANG RD QIANDENG TOWN, KUNSHAN CHINA
 Tel : +86-21-56633709
 Email: JILL.SHEN@BLUEPARD.COM
 Authorised Representative :Giorgio Bormac S.r.l – Via della Meccanica, 25 41012 Carpi (MO)-ITALY

Object of Declaration: :WATER BATH WITH PUMP

This declaration of conformity is issued under the sole responsibility of the manufacturer.

Product names:
Product description WATER BATH PUMP
Model: BWS-27G, BWS-40G
Serial Number: from s/n 200100001 to 2600100001
Product options: This declaration covers all options of the above products

- *The object of the declaration describe above complies with the essential requirements of the following applicable European Directives, and carries the CE marking accordingly:*

EMC directive: 2014/30/UE	<i>Directive 2014/30/EU of the European Parliament and of the Council of 26 February 2014 on the harmonization of the laws of the Member States relating to electromagnetic compatibility.</i>
RoHS Directive 2011/65/EU	<i>Directive 2011/65/EU of the European Parliament and of the Council of 8 June 2011 on the restriction of the use of certain hazardous substances in electrical and electronic equipment.</i>
LVD Directive: 2014/35/UE	<i>Directive 2014/35/EU of the European Parliament and of the Council of 26 February 2014 on the harmonization of the laws of the Member States relating to the making available on the market of electrical equipment designed for use within certain voltage limits Text with EEA relevance.</i>
Machinery Directive : 2006/42/EC	<i>DIRECTIVE 2006/42/EC OF THE EUROPEAN PARLIAMENT AND OF THE COUNCIL of 17 May 2006 on machinery, and amending Directive 95/16/EC (recast)</i>

- *and conforms with the following standards:*

EN 61010-1:2010+A1:2019

EN 61326-1:2013

EN 61000-3-2:2014

EN 61000-3-3:2013

EN 60204:2018

EN ISO 12100:2010

NAME AND ADDRESS OF THE PERSON AUTHORISED TO COMPILE THE TECHNICAL FILE

Giorgio Bormac S.r.l. - Via della Meccanica, 25 41012 Carpi (MO) - ITALY

Signed for and on behalf of:

XIE WEIMIN

Place





24/09/2020

SHANGHAI

SIGNATURE _____



Fac-simile of the CE marking plate:

 Add:108 Gongxiang Rd., Kunshan China  	Name Water Bath	
	Model BWS-27/BWS-27G/WB 22/WB 22 Pump	
	Volts 220V/50Hz	Watts 1100W
	Temp. Range RT+5°C ~ 85°C/100°C	
	S/N 201120103	Date: 2021. 01
	 Made in P.R.C.	





4. Content of the package

The instrument is delivered complete with the following parts:

1. Stainless steel bottom plate.
2. Emptying tank kit.
3. Power cable.
4. Fuse.
5. User manual.

5. Transportation

• Instructions for safe transportation

 ATTENTION	
  	<p>Risk of injury, of slipping or overturning and Risk of damage to the instrument.</p> <ul style="list-style-type: none"> ➤ The instrument must be lifted by 2 people. ➤ The instrument must be transported in its original packaging only. ➤ The instrument must always be lifted from below with mechanical tools (e.g., forklift truck) together with the supporting pallet. <ul style="list-style-type: none"> ⊘ The instrument must not be lifted directly from below with mechanical tools without supporting pallets (e.g., forklift truck). ⊘ The instrument must not be lifted or dragged by pulling the door.

• Transportation of an already used water bath

- Switch off the Argolab water bath by pressing the main switch.
- Remove the power plug from the socket.
- Remove the bottom plate.
- Clean the Argolab water bath and the bottom plate (see chap. 16).
- Dry the inside of the Argolab water bath, the bottom plate and the emptying tank kit.
- Wrap the bottom plate, the emptying tank kit and the power cable with pluriball and placed them into the tank of the water bath.
- Completely pack the water bath with its original packing.
- Take care that the Argolab water bath do not wet during transport.
- During transport keep the room temperature allowed (from -10 °C to 60°C).



6. Conservation

Store the Argolab water bath only in closed and dry rooms.

The permitted storage temperature is from -10 °C to 60 °C, the permitted storage humidity is 85% RH without condensation.



7. First installation



• Preliminary operations

The water bath should be installed in following conditions:

1. Dry, clean, stable worktable with a flat horizontal surface and heat resistant.
2. At least 20 cm free around the instrument.
3. Room temperature between 5 °C and 40 °C and relative humidity no more than 85%.
4. Power supply socket with earth connection.
5. Power supply 220-240 V - 50 Hz.



 ADVICE	
	<p>Risk of overheating - Damage to the instrument</p> <ul style="list-style-type: none"> ⊘ DO NOT install the instrument in not ventilated area. ➤ Ensure that there is enough ventilation to disperse heat.

 DANGER	
	<p>Risk of explosion and death</p> <ul style="list-style-type: none"> ⊘ DO NOT operate the device in potentially explosive areas. ⊘ DO NOT use explosive dust or air-soluble mixtures in the environment.

8. Instrument parts



Figure 1

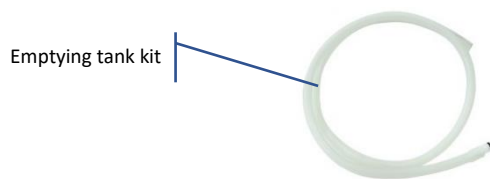

Figure 2

- Display and commands



Figure 3

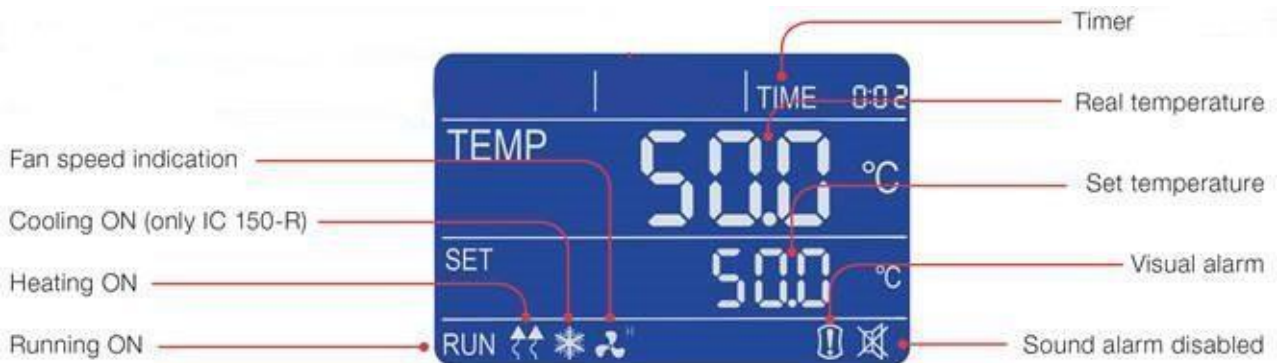







Figure 4

COMMAND	DESCRIPTION
	The SET/PROG button allows you to set the working parameters and to enter/exit from the programs. In combination with the SHIFT key, it allows you to access to menus with password (see paragraph 10).
	The SHIFT button allows you to quickly change the digit (decimal, units, tens, etc.) of the value of the parameter you are editing. In combination with the SET/PROG key allows you to access to menus with password (see paragraph 10).
	Adjustment buttons allow you to increase or decrease the value of the operating parameter being edited.
	The START / STOP button allows you to start / stop an operating cycle or a program.
	The ON/OFF button allows to turn on or off the instrument. The ON/OFF "Pump" button allows you to turn on or off the circulation pump (if installed).

9. Technical specifications

Water bath with natural convection	WB-5	WB-12	WB-22
Maximum volume	5 Litres	12 Litres	22 Litres
Max. temperature / Resolution	+ 100 / 0,1°C	+ 100 / 0,1°C	+ 100 / 0,1°C
Homogeneity at 37°C	± 0,2 °C	± 0,5 °C	± 0,5 °C
Temperature variation at 37°C	± 0,1 °C	± 0,1 °C	± 0,1 °C
Recirculation pump	No	No	No
Timer	99:59 e ∞	99:59 e ∞	99:59 e ∞
Overtemperature protection	Yes	Yes	Yes
Safety class	2	2	2
Dimensions of the bottom plate	270 x 125 mm	250 x 205 mm	450 x 265 mm
Useful height with closed cover	110 mm	150 mm	150 mm
Power supply / Power	230 V / 700 W	230 V / 900 W	230 V / 1100 W
External dimensions	480 x 215 x 350 mm	480 x 380 x 310 mm	680 x 390 x 365 mm
Weight	8 Kg	12 Kg	18 Kg
Rack	2	4	8

Water bath with forced circulation	WB-22 Pump	WB-40 Pump
Maximum volume	22 Litres	40 Litres
Max. temperature / Resolution	+ 85 / 0,1°C	+ 85 / 0,1°C
Homogeneity at 37°C	± 0,2 °C	± 0,5 °C
Temperature variation at 37°C	± 0,1 °C	± 0,2 °C
Recirculation pump	No	No
Timer	99:59 e ∞	99:59 e ∞
Overtemperature protection	Si	Si
Safety class	2	2
Dimensions of the bottom plate	450 x 265 mm	620 x 380 mm
Useful height with closed cover	150 mm	150 mm
Power supply / Power	230 V / 1100 W	230 V / 2200 W
External dimensions	680 x 390 x 365 mm	830 x 390 x 460 mm
Weight	18 Kg	28 Kg
Rack	8	16

Rack description	Modules
Rack 1 for pipes Ø 13 mm / 20 places	1
Rack 2 for pipes Ø 18 mm / 20 places	1
Rack 3 for pipes Ø 31 mm / 5 places	1
Rack 4 for pipes Ø 56 mm / 8 places (baby bottle)	3
Rack 5 for blood sachets / 5 places	3

10. Filling of the tank



Fill the tank with deionized or osmotized water. The water level must always be above the outlet nozzle of the pump (where present), or in any case in such quantity as to leave uncovered the heating element (see Figure 5).

ATTENTION: during the filling of the tank, it must always consider the natural evaporation of water. You must therefore always maintain a sufficient level of water (at least 4-5 cm below the upper edge of the tank, see Figure 5).

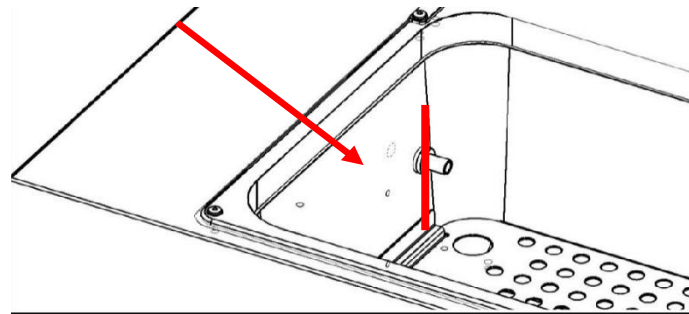











Figure 5

 ATTENTION	
 	<p>Risk of injury</p> <ul style="list-style-type: none"> ➤ Use water in the inside of the instrument.
 WARNING	
	<p>Risk of injury and burns</p> <ul style="list-style-type: none"> ➤ The water bath is projected to be used only with non-flammable liquids. ➤ DO NOT use the water bath if there is no water inside of the instrument. ⊘ DO NOT introduce liquids / flammable material into the instrument.
 DANGER	
	<p>Risk of explosion and death</p> <ul style="list-style-type: none"> ⊘ DO NOT use explosive substances with the water bath.

11. Emptying of the tank

 ATTENTION	
 	<p>Risk of injury</p> <ul style="list-style-type: none">➤ Empty the instrument when the water-bath is not heating and the heating element is not hot.➤ Remove the water when it is at room temperature.⊘ DO NOT empty the instrument when is functioning.

The water bath Argolab are equipped with an emptying kit with quick release.

1. Turn off the working cycle.
2. Wait for the cooling of the water inside the water bath.
3. Turn off the recirculation pump by pressing the ON/OFF “Pump” button (for models equipped with pump).
4. Connect the emptying tank kit supplied to the emptying valve placed in the frontal part of the instrument (see Figure 6).
5. Fill the end of the kit sufficiently.
6. The water automatically flows into the tank through the emptying tank kit.
7. If necessary, remove the last traces of water with an absorbent cloth or paper.
8. Disconnect the emptying tank kit from the valve in the water bath through the metallic locking device placed over the emptying valve (see Figure 7).

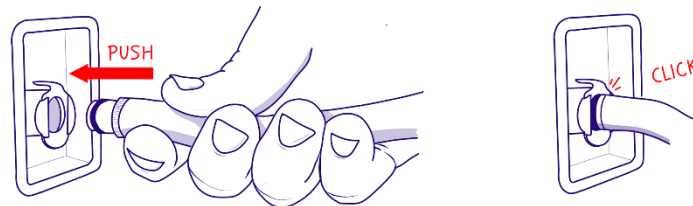

Figure 6 – Emptying tank kit

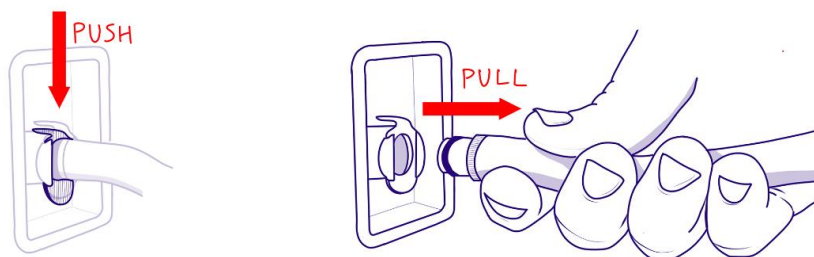



Figure 7 – Emptying tank kit

12. Functioning

• Switching on the instrument

Connect the cable to power supply socket with earth connection. Turn on the instrument by pressing the ON /OFF button. The display switches on.

The display shows the initialisation sequence and then the instrument is ready to use.

NOTE: every time you turn on the instrument, it beeps intermittently, the icon of visual alarm  and the text “end” appear on the instrument, indicating that a heating cycle had been completed before switching it off. Press any button to silence the audible signal and the icon  appears on the display.





- **Turn on/off the recirculation pump (If present)**

If installed, the recirculation pump can be switched on or off any time by pressing the ON/OFF “Pump” button. The pump can be operated only if the main button ON/OFF is in ON position.





NOTE: at the first use or after emptying of the tank of the water bath, it is possible that inside the pump there is an air bubble and therefore it could no-load operate. If during this stage you hear an abnormal sucking sound aspiration, turn off the pump and bring the water level above the exit nozzle of the circuit pump (see Figure 5).



- **Setting of parameters**

Working temperature





When the instrument is on, press once the SET/PROG  button, the set temperature value starts flashing. Set the desired value (degree centigrade) by pressing the keys . It is possible to move quickly between digits by using the SHIFT  button. Confirm the value with another press of the SET/PROG  button.

Working time

After confirming the temperature value by pressing the SET/PROG  button, the last value of the set time (timer) starts flashing. Set the desired value (hh:mm) by pressing the keys . It is possible to move quickly between digits by using the SHIFT  button. Confirm the value by pressing the SET/PROG  button again.



NOTE: the value “00:00” indicates the operating mode “continuous”, that means once you start the working cycle by the START/STOP  button, it continues keeping the set temperature until it is stopped manually (START/STOP  button).



- **Start/Stop heating cycle**

After setting the working parameters, press the START/STOP  button with a long press (4-5 seconds), the heating cycle starts for the set time hh:mm or in continuous (00:00). The word “end” at the top right of the display disappears, the word **RUN** appears at the bottom left and the display shows simultaneously: timer, set temperature and measured temperature at the inside of the tank (see 4). At any time, you can always stop the cycle by long pressing the START/STOP  button (4-5 seconds). Once the set time and after a manual stop, the instrument beeps intermittently, the icon of visual alarm  and the word “end” appear on the display. Press any button to silence the audible signal and the icon  appears on the display.

NOTE: the acoustic signal will not end until it is stopped by the operator, but the heating cycle is ended so the samples into the instrument will remain exposed to the internal temperature of the tank.

13. Access to submenu with password

By pressing the SET/PROG  and SHIFT  keys simultaneously for a few seconds, it is possible to access some password-protected functions and parameters.

To access these sub-menus and avoid entering the operating parameters by mistake, it is advisable to first press the SHIFT key  and then, while holding it down, also press the SET/PROG key  for few seconds.

Once this operation has been carried out, the word "Lk" (lock) appears in the top right-hand corner of the display in place of the word TIME, next to the digits "0000" (password).

Here below, you can find the passwords and the access sequence to the various parameters/functions.

PASSWORD	FONCTION/PARAMETERS	DESCRIPTION
0000	dy	Delay start function of the heating cycle
0003	tm	Temperature limit for samples protection
	Po	Restart mode after absence of power energy
	AL	Temperature limit for over-temperature alarm
	Pb	Offset temperature on one point
	PK	Offset temperature on the entire ramp
	PA	Offset temperature on room temperature sensor

- **Delay start function**

It is possible to set a delay (hours and minutes) of heating cycle start.







Set the delay start function before a working cycle starts. Follow the instructions at the paragraph “access to submenu with password” and confirm with the password “0000” pressing shortly one time the SET/PROG button. On the top right of the display the parameter “dy” (delay) and the value 00:00 appear. Set the desired start delay value (hh:mm) by pressing the keys .

You can move quickly between the figures using the SHIFT key . Confirm the value by pressing SET/PROG button .

again, the display returns to the standby screen. By long pressing the START/STOP key  (4-5 seconds), the instrument starts the program, but does not start heating immediately: the word "end" in the top right-hand corner of the display and the delay time flash alternately, marking the wait from the set delay time to the actual start. Once the set delay time has elapsed, the instrument starts the program and the regular timer appears on the display.

- **Temperature limit for the sample protection**

The instrument foresees the possibility of limiting the maximum working temperature to protect the samples from an incorrect temperature setting of the heating cycle.

Follow the instructions in paragraph “Access to submenu with password” and use the keys  to set the password “0003”. You can move quickly between the digits using the SHIFT key . Confirm the value by pressing SET/PROG button  again. The display in the top right-hand corner shows the parameter "tm" (max. temperature) and the maximum value for that type of instrument (different between oven and incubator). Set the maximum temperature value that you do not want the instrument to exceed during operation by pressing the keys . You can move quickly between the digits using the SHIFT key . Confirm the value by pressing SET/PROG button  again.

Example







If the temperature set for the heating cycle is 100 °C and a limit temperature (tm) of 70 °C is set, the instrument will attempt to reach the temperature indicated during parameter setting (100 °C), even if it is higher than the limit temperature set in this submenu (tm). When 70°C is reached the instrument goes into alarm with an intermittent acoustic signal (can be silenced by pressing any key) and the heating element does not receive power supply until the temperature decrease to the safety temperature.

NOTE: the instrument tries in every moment to achieve the set heating temperature and until it is more than the limit one, the instrument goes in over temperature alarm as explained in the previous paragraph.

- **Restart mode after the absence of the power supply**



It is possible to set a restart mode after a power supply absence:





VALUE Po	DESCRIPTION
0	When the power supply returns, the instrument does not automatically resume the heating cycle, but it is necessary to restart it manually.
1	When the power supply returns, the instrument automatically resumes its functioning from the beginning of the interrupted heating cycle.
2	When the power supply returns, the instrument automatically resumes its functioning from the exact point of the heating cycle in which it was interrupted.

Follow the instructions at paragraph “access to submenu with password” and use the keys  to set the password 0003. You can move quickly between the digits using the SHIFT key . Confirm the value by pressing SET/PROG button  again. The parameter "tm" (max. temperature) appears in the top right-hand corner of the display, move on to the next parameter "Po" (Power) by pressing SET/PROG button  again. Set the desired value (0, 1, 2) by pressing the keys . Confirm the value by pressing SET/PROG button  again.

- **Temperature limit for over-temperature alarm**

It is possible for the user to set the temperature value beyond which the instrument goes into overtemperature alarm.



NOTE: even if this value can be modified by the operator, in any case it is already set by the producer and perfectly calibrated for this type of instrument. It is therefore advisable not to modify this value unless strictly necessary, as temperature fluctuations above or below the set value, especially in natural convection models, are completely normal and therefore reducing the AL value excessively would risk causing the instrument to go into alarm frequently and unnecessarily. Follow the instructions in paragraph "Access to submenu with password" and use the keys  to set the password **0003**. You can move quickly between the digits using the SHIFT key .

Confirm the value by pressing SET/PROG button  again. The parameter "tm" (max temperature) will appear on the display in the top right-hand corner, briefly press the SET/PROG key  to move on to the next parameters. When you reach the **AL** (alarm) parameter, set the minimum temperature value above which you want the instrument to go into an overtemperature alarm by pressing the keys . You can move quickly between the digits using the SHIFT key . Confirm the value by pressing SET/PROG button  again.

- **Temperature offset on single point, on the entire range, on room temperature sensor**

The instrument allows the user to set the offset values, i.e., the calibration values, on a temperature point, on the entire temperature range and on the room temperature range.





NOTE: although they can be modified by the operator, these values are already set by the factory and perfectly calibrated with certified measuring instruments and Accredia references. It is therefore advisable not to modify these values unless strictly necessary, for example, if a certified digital thermometer reveals inconsistencies between the temperature readings of the instrument and those taken by the thermometer itself. Follow the instructions in paragraph "Access to submenu with password" and use the keys  to set the password **0003**.

You can move quickly between the digits using the SHIFT key . Confirm the value by pressing SET/PROG button  again. The parameter "tm" (max. temperature) will appear on the display in the top right-hand corner, briefly press SET/PROG button  to move on to the next parameters until the desired ones are reached.







PARAMETER	DESCRIPTION
Pb	By modifying this parameter, it is possible to correct the reading of the PT100 temperature sensor inside the instrument to a single temperature point. The correction will therefore be referable to only one specific point.
PK	By modifying this parameter, it is possible to correct the reading of the PT100 temperature sensor inside the instrument over the entire temperature range, i.e., it is possible to vary the inclination of the reading range of the sensor itself.
PA	By modifying this parameter, it is possible to correct the reading of the PT100 room temperature sensor installed on the instrument (refrigerated versions only) to a single temperature point. The correction will therefore be referable to only one specific point.

14. Clean and maintenance

A correct maintenance and cleaning of the instrument ensure that it remains in good condition. The internal tank of the instrument is made of stainless steel, so it can be cleaned with any detergent provided that is not aggressive and/or corrosive.

 DANGER	
  	<p>Risk of electric shock and death</p> <ul style="list-style-type: none"> Ø DO NOT spray water or cleaning agents onto the interior and exterior surfaces. Ø Switch off the main switch and pull out the mains plug before cleaning. ➤ Dry the instrument completely before switching it on again.

It is recommended to clean the internal/external surfaces with a standard multiuse detergent sprayed on a soft dampened cloth. Before proceeding with cleaning or decontamination, the user must ensure that the method used does not damage the instrument.

 ATTENTION	
	<p>Risk of corrosion – Damage of the instrument</p> <ul style="list-style-type: none"> Ø DO NOT use cleaning agents containing acids or halides. Ø DO NOT use neutral cleaning agents on other surfaces (e.g., on galvanised parts of the hinges or the rear wall of the housing).
   	<p>Eyes contact – Eyes damages caused by chemical burns</p> <ul style="list-style-type: none"> Ø DO NOT discharge into the sewage system. <ul style="list-style-type: none"> • Wear safety goggles.

IMPORTANT:

If the instrument must be returned for service, it is necessary to provide for proper cleaning and possible decontamination by pathogens of the same.

It is also recommended to pack the instrument into its original packing to send it for repairs. Any damage caused by an incorrect shipping will not be covered by warranty.

15. Warranty

Under normal use this instrument is guaranteed for a period of 24 months from the date of purchase. The warranty is valid only if the product purchased remains original. It does not apply to any product or parts thereof that have been damaged due to incorrect installation, improper connection, misuse, accident or abnormal operating conditions. No liability is accepted for damages caused by improper use, lack of maintenance and unauthorised modifications.

16. Disposal of electronic equipment



This equipment is subject to the regulations for electronic devices.
Dispose of in accordance with local regulations.

